

# Installation & Operation Manual

## Wireless Thermostat

Model

---

**NRC-10R**

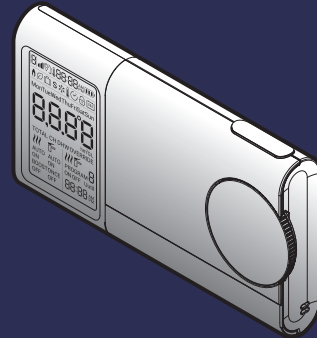

#### Copyright information

- KD Navien , Inc. All rights reserved.
- Wi-Fi®, the Wi-Fi CERTIFIED logo, and the Wi-Fi logo are registered trademarks of the Wi-Fi Alliance.
- Trademarks and trade names used in this manual are the property of their respective owners.

If your device requires service, you have several options for getting service, contact Technical Support at 0844 332 2323 or on the website: <https://navienuk.com/>

For warranty service, always contact Technical Support first.

**TEL:** 0844 332 2323

**Add:** Building 2, Ground Floor, Guilford Business Park, Guildford GU2 8XH.

# Safety information

---

Read and follow all safety instructions in this manual to avoid unsafe operating conditions, property damage, personal injury, or death.

## Safety messages used in this manual



### WARNING

Indicates a potentially hazardous situation which, if not avoided, could result in injury or death.



### CAUTION

Indicates a potentially hazardous situation that, if not avoided, could result in property damage.



## WARNING

- **This device is designed for indoor use. Please install and use this device indoors.**
- **Do not disassemble or attempt to repair the device.**
  - You may damage the device.
  - Any attempt to disassemble or repair the device voids Navien's Limited Warranty. Navien is not responsible for damage or injuries caused by voiding the Navien's Limited Warranty.
- **Do not store flammable materials near the device.**
  - This may cause a fire or damage the device.
  - Keep all flammable products far away from the device and store them in approved containers. Keep the containers closed tightly and out of the reach of children and pets.



## WARNING

- **Avoid interference with other electronic devices.**
  - The device emits radio frequency (RF) signals that may interfere with unshielded or improperly shielded electronic equipment, such as pacemakers, hearing aids, medical devices, and other electronic devices. Consult the manufacturers of your electronic devices to solve any interference problems you experience.
- **When mounting the device on a wall, make sure that the wall is strong enough to support the device.**
  - The device could fall if the wall is not strong enough and this may damage the device or cause injury.
- **Do not use unauthorised or damaged batteries.**
  - Using unauthorised or damaged batteries may cause fire, explosion, leakage.
- **Do not heat the batteries or throw them into fire.**
  - This may cause a fire.



## CAUTION

- **Use suitable tools and appropriate force to install the device.**
  - Using unsuitable tools or excessive force during installation may damage the device.
- **Do not expose the device to direct sunlight or high temperatures for an extended period of time.**
  - Prolonged exposure to sunlight or extreme temperature may cause permanent damage to the device's internal components.
- **Avoid water and wet areas.**
  - This may damage the device's internal components. Always keep the device dry.
- **Do not clean the device with water or a damp cloth.**
  - You may damage the device.
- **Do not install the device in very hot or very cold areas. The operating temperature of the device is 0°C–40°C.**
- **This device has been approved for use in the UK and EU only.**
  - Using the device in any other country will void the manufacturer's warranty.

# Contents

---

## Overview ..... 7

Supplied items.....9

Device layout .....10

About the LCD screen icons.....11

## Installing the wireless thermostat..... 14

Inserting the batteries .....14

Placing on a table .....15

Attaching the wall mounting bracket.....16

## Selecting the zone number ..... 17

## Pairing with the wireless communication module..... 18

## Using the central heating system ..... 20

Adjusting the central heating temperature .....20

Selecting the central heating mode .....21

Setting the central heating program  
(Schedule settings) .....22

## Using the domestic hot water (DHW) .. 25

Selecting the domestic hot water mode.....25

Setting the domestic hot water program  
(Schedule settings) .....26

## Viewing basic information ..... 29

## Using advanced functions..... 30

Using child-lock mode .....30

Using holiday mode .....31

Using the pre-heat function .....32

Using the freeze protection function.....33

---

**Setting the user configurations ..... 34**

Selecting 12H 24H format .....34

**Setting the installer configurations .... 35**

Changing the zone number .....35

Calibrating the indoor temperature .....36

Testing the RF signal .....37

Setting the program day .....38

Setting the date and time .....40

Resetting the accumulated fuel usage and  
operation time .....41

Resetting the wireless thermostat .....42

**Troubleshooting..... 44**

**Error Code Guide..... 45**

**Recycling and disposal ..... 46**

Recycling the package ..... 46

WEEE: Recycling or disposing of the device  
and its parts .....46

**Warranty..... 47**

**Specifications ..... 48**

# Overview

---

Navien Smart Plus uses 2-way communication on an 868 MHz radio frequency (RF) band to control the heating system. The wireless communication module (BCM-40RW) operates as the control centre of the system, and the Navien boilers (LCB700 or NCB-CE) support 2-wire communication (KIW) technology. It is possible to control it using a 2-wire connection from the BCM-40RW terminals.

Navien Smart Plus consists of the wireless thermostat (NRC-10R) and wireless communication module (BCM-40RW). The devices are already paired (completed RF pairing procedure). Therefore, when installing them, no additional initial pairing procedure is needed to use the devices.

Navien Smart Plus can be installed in combi/system and regular boilers. With an additional wireless thermostat (NRC-10R) and an additional wireless wiring centre (VCU-10R), multizone control can be implemented in a combi boiler environment via the S/S+ Plan and in a system/regular boiler environment with the S/S+/Y/W Plan.

Applicable devices with NRC-10R	Specifications			
	Model name	Power input	Radio frequency (RF)	Wi-Fi
Wiring centre	VCU-10R	230 VAC, Hz	868 MHz	-
Wireless communication module	BCM-40RW	Navien boiler (power line along with communication line)	868 MHz	2.4 GHz, IEEE Std. 802.11b/g/n (20 MHz)
Main controller (boiler)	LCB700 or NCB-CE	230 VAC	-	-

Charge for App service is subject to be imposed after prior notice in accordance with the policy of the manufacturer.

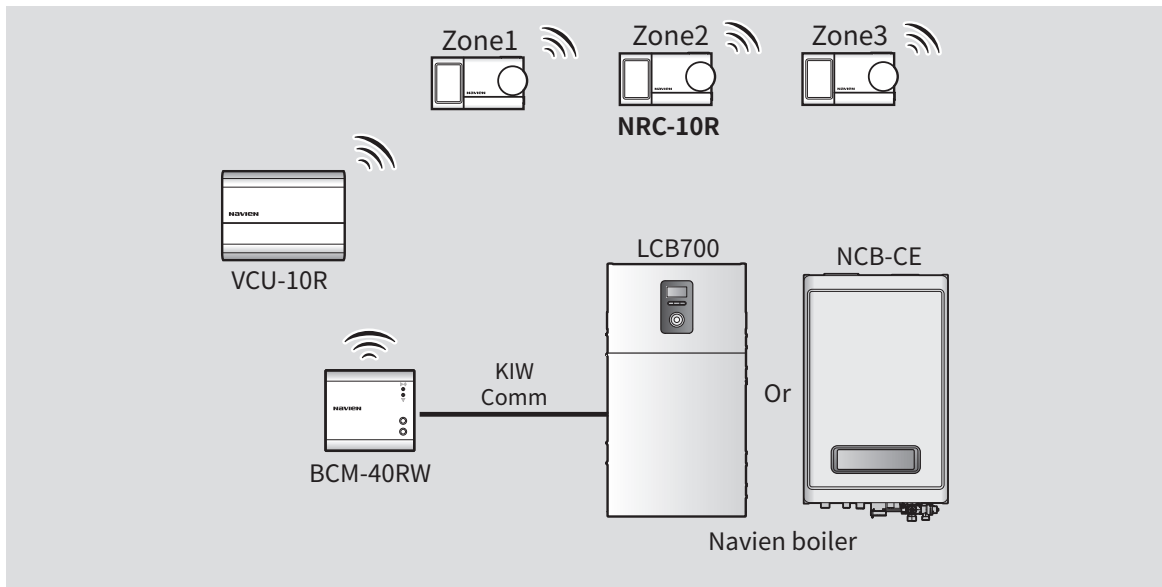

- This device specifications or contents of this manual may be changed without prior notice due to upgrade of device functions.
- The device functions can be limited by the operating environment.



---

## Supplied items

Open the packaging and ensure that the following items are provided.

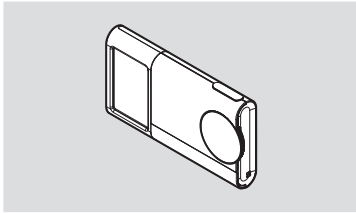

Wireless thermostat

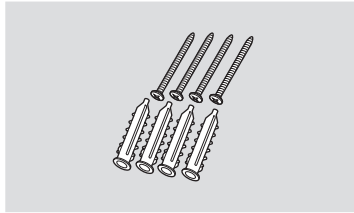

Screws and anchors

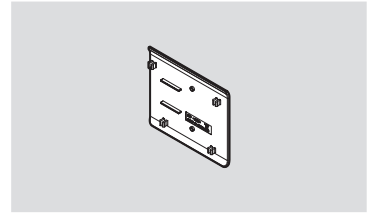
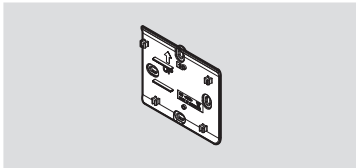
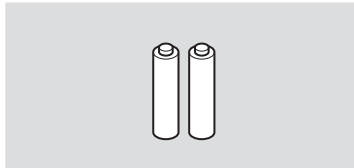

Table stand



Wall mounting plate



AA Alkaline 1.5 V batteries



Installation & Operation manual

## Device layout



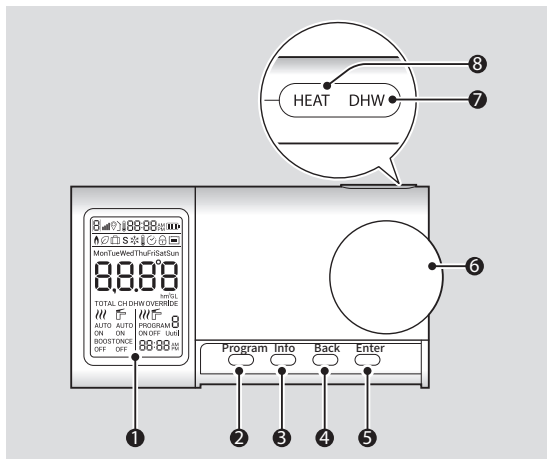

The following table provides brief information on each part of the wireless thermostat.















No	Name	Description
1	LCD screen	Displays functions and current status.
2	Program button	Press to set program schedules for the central heating or domestic hot water system.
3	Info button	Press to display operation and program information.
4	Back button	Press to go back to the previous stage or cancel settings.
5	Enter button	Press to confirm the settings.
6	Encoder (+, -)	Rotate to adjust the central heating temperature or set programs for central heating or domestic hot water.
7	DHW button	Press to set for domestic hot water operation.
8	HEAT button	Press to set for central heating operation.



## About the LCD screen icons



The following table provides brief information on all the LCD screen icons displayed while using the wireless thermostat.

Icon	Name	Description
	Zone number	Displays the zone number of the installed thermostat.
	RF signal strength	Indicates the RF communication signal strength.
	Geo-fencing	Indicates that the geo-fencing function is enabled.  The geo-fencing function can be enabled via the Navien Smart Plus app and allows you to turn off the central heating system automatically when you are away from home.

Icon	Name	Description
	Outdoor temperature compensation	Indicates that the outdoor temperature compensation function is enabled.  The outdoor temperature compensation function can be enabled via the Navien Smart Plus app. If the boiler performs the outdoor temperature compensation function, the outdoor temperature compensation icon is displayed on the LCD screen when the outdoor temperature compensation data from the server is sent to the wireless thermostat.
	Time	Displays the current time.
	Battery	Displays the remaining battery amount.

Icon	Name	Description
	Combustion	Indicates that the central heating or direct hot water system is in combustion.
	Eco mode	Indicates that the boiler is in Eco mode.
	Freeze protection	Indicates that freeze protection is enabled.
<b>S</b>	Pre-heating	Indicates that pre-heating is on.
	Holiday mode	Indicates that Holiday mode is enabled.
	Temperature setting	Indicates that central heating operation temperature is being set.
	Time setting	Indicates that time format is being set.
	Child lock	Indicates that the child lock function is enabled.
	Maintenance time	Indicates that maintenance is required.

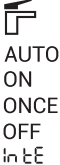
Icon	Name	Description
MonTueWed ThuFriSatSun	Days	Displays the current day.
	Information	Displays the current and set temperature, total usage time, and amount of oil consumption.
TOTAL CH DHW OVERRIDE	Consumption	Displays the consumption type in Information mode.
 AUTO ON BOOST OFF	Central heating operation	Displays the set central heating (CH) mode. <ul style="list-style-type: none"> <li>• AUTO: The set program mode for CH is on.</li> <li>• ON: CH operation is on.</li> <li>• BOOST: The boost function is enabled.</li> <li>• OFF: CH operation is off.</li> </ul>

Icon	Name	Description
 <p>AUTO ON ONCE OFF IntE</p>	Domestic hot water operation	<p>Displays the set domestic hot water (DHW) mode.</p> <ul style="list-style-type: none"> <li>• AUTO: The set program mode for DHW is on.</li> <li>• ON: DHW is on.</li> <li>• ONCE: The once function is enabled.</li> <li>• OFF: DHW is off.</li> <li>• IntE (Intelligent): Pre-heating before domestic hot water operation is automatically performed based on cumulative user patterns.</li> </ul>
 <p>PROGRAM 8 ON OFF Util 88:88 AM PM</p>	Program mode	Displays the set program mode for domestic hot water (DHW) or central heating (CH).

# Installing the wireless thermostat

---

You can place the wireless thermostat on a stable, flat surface using the supplied table stand or install the wireless thermostat on a wall using the supplied wall mounting plate. For the best RF system performance, install the wireless thermostat in an open area so that it can pair with the communication module.



Do not install the wireless thermostat near heat sources, such as radiators, chimney walls, televisions, or direct sunlight. Doing so may damage the device.



Install the wireless thermostat at least 30 cm from any metal objects, including wall boxes, and at least 1 m from any other electrical equipment, such as radios, televisions, and PCs. Metal objects and electrical equipment may affect the RF communication between RF devices.

## Inserting the batteries

Before installing the wireless thermostat, insert the supplied AA Alkaline 1.5 V batteries into the back of the wireless thermostat ensuring correct polarity.

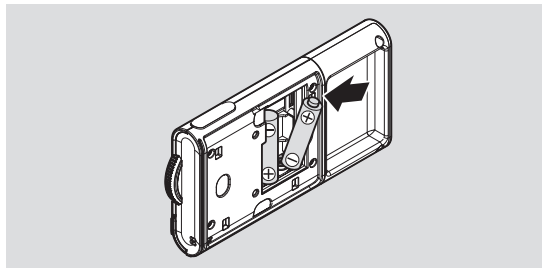

If the batteries are properly inserted, the wireless thermostat will be turned on.



- Do not use unauthorised or damaged batteries. Using unauthorised or damaged batteries may cause fire, explosion, leakage.
- Do not heat the batteries or throw them into fire. This may cause a fire.



- The normal working life of the battery is approximately 1 year. However, battery life may vary depending on conditions, environmental factors, functions of the device in use.
- If the low battery icon (  ) is displayed on the LCD screen, replace them with new ones.
- When removing the used battery, dispose it properly according to the local or national laws.

## Placing on a table

Check the direction of the table stand and attach it to the back of the wireless thermostat.

You will hear a "click" sound when the wireless thermostat is securely attached.

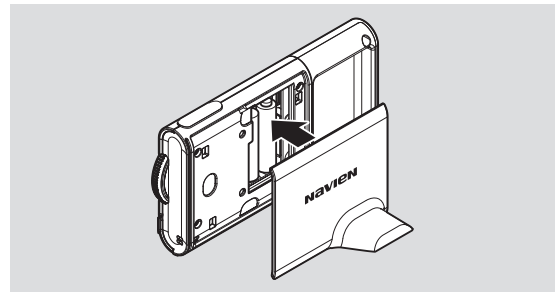

Ensure that nothing is blocking the device's internal antenna area.

## Attaching the wall mounting bracket

- 1 Check the direction of the wall mounting plate and affix it to the wall using four screws.



Maintain a minimum clearance of 1.2 m from the floor.

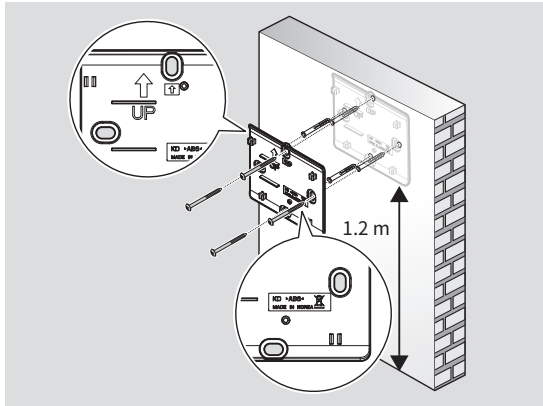

- 2 Hang the wireless thermostat on the wall mounting plate by aligning the hooks. You will hear a "click" sound when the wireless thermostat is securely hung.

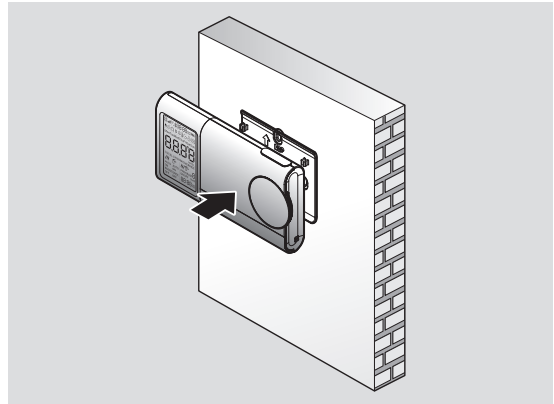



## Selecting the zone number

Before pairing with the communication module, enter RF pairing mode for the wireless communication module, and then set the zone number for the wireless thermostat. You can select a zone number from [1] to [3].



When adding a zone, do not use the same zone number as the existing wireless thermostat. If this is the case, the thermostats will not operate correctly.

- 1 On the wireless communication module, enter RF pairing mode.
- 2 When the wireless thermostat is turned on for the first time, rotate the encoder up or down to select a desired zone number.

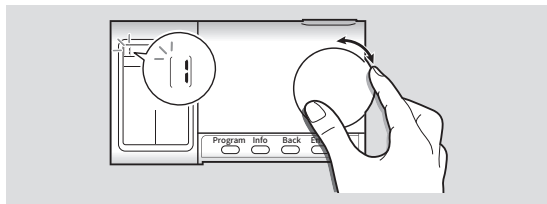

- 3 Press the Enter button to confirm the zone number. The wireless thermostat will be paired with the wireless communication module automatically. If the wireless thermostat is paired with the wireless communication module successfully, the set temperature and the RF signal strength icon (  ) will be displayed on the LCD screen.

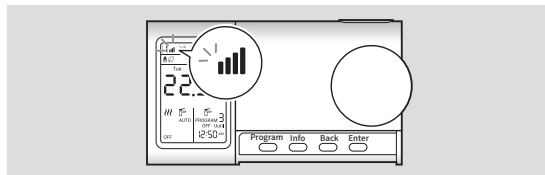

- To use DHW mode and set the calendar, select [1]. Depending on the boiler types, DHW mode may not be usable.
- To change the zone number after having selected and confirmed it, refer to “Changing the zone number” on page 35.

# Pairing with the wireless communication module

If the wireless thermostat is not automatically paired with the wireless communication module after selecting and confirming the zone number for the wireless thermostat, pair the wireless thermostat with the wireless communication module manually.

- 1 On the wireless communication module, enter RF pairing mode when the RF signal strength icon (  ) and 'Pair' is displayed on the wireless thermostat LCD screen.



If additional wireless thermostats need to be paired with the communication module, maintain the communication module in RF pairing mode until you complete pairing for all the wireless thermostats.

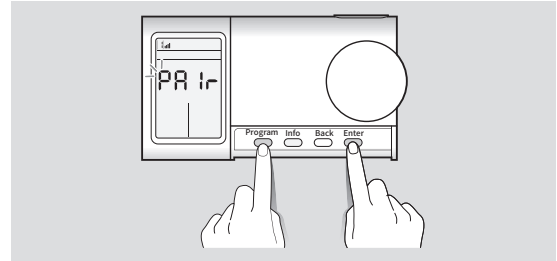

- 2 On the wireless thermostat, press and hold the Program and Enter buttons simultaneously for 3 seconds to enter pairing mode.

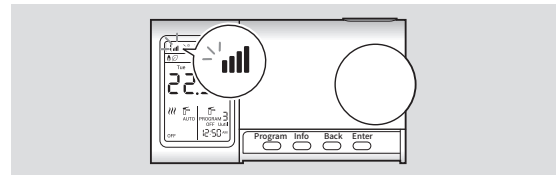

If the wireless thermostat is paired with the wireless communication module successfully, the set temperature and the RF signal strength icon (  ) will be displayed on the LCD screen.



---

3 On the wireless communication module, exit RF pairing mode after completing pairing all the wireless thermostats with the wireless communication module, and then check if the RF signal strength icon (  ) is displayed on the wireless thermostat LCD screen. If the RF signal strength icon (  ) is not displayed, pair the wireless thermostat with the wireless communication module again.



- If the wireless thermostat is not paired with the communication module successfully, 'Fail' will be displayed on the LCD screen. Check that the communication module is in pairing mode properly and pair the wireless thermostat with the communication module again.
- If the communication module is connected to the Wi-Fi network, the date and time on the wireless thermostat LCD screen will be automatically updated via the Wi-Fi network. To set the time and date manually, refer to "Setting the date and time" on page 40.

# Using the central heating system

## Adjusting the central heating temperature

Adjust the central heating temperature for the selected zone.

- 1 In normal operation mode, press the HEAT button. The set temperature will be displayed on the LCD screen.

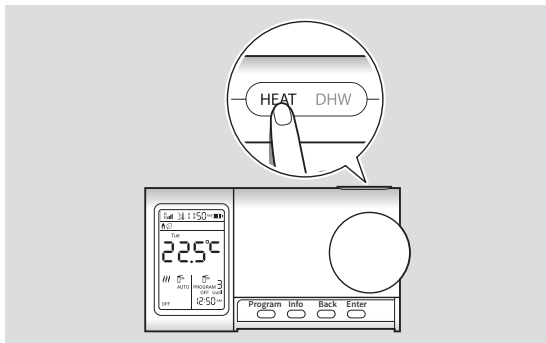

- 2 Rotate the encoder up or down to select the desired central heating temperature.

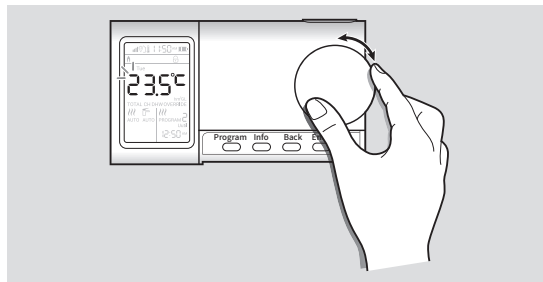

## Selecting the central heating mode

You can select the various central heating system modes for the selected zone. To select a central heating mode, press the HEAT button sequentially to select the desired central heating mode (AUTO, ON, and OFF).

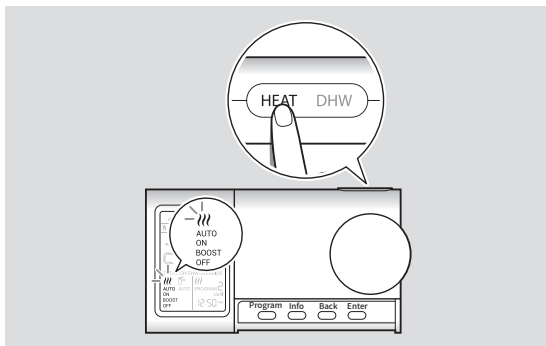

To select BOOST mode, press and hold the HEAT button. Each central heating mode is explained in the following table.

Name	Description
AUTO	Central heating is operating at the set time and temperature that was set in CH program mode (Weekly Schedule).
ON	Central heating is operating at the set temperature.
OFF	Central heating is not operating.
OVERRIDE	After adjusting the central heating temperature during AUTO mode, central heating is operating at the adjusted temperature for the current program time period.
BOOST	Central heating is operating at the set temperature for an hour.

## Setting the central heating program (Schedule settings)

If you set a central heating program (Schedule settings), you can select the desired day and time to operate the central heating system.

- 1 Press the Program button to enter Program mode. “ProG” will blink on the LCD screen.

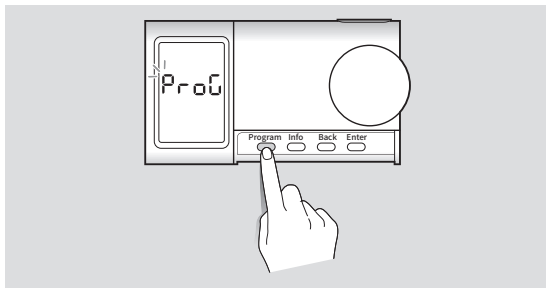

- 2 Press the HEAT button to enter CH Program mode. The days of the week will blink on the LCD screen.

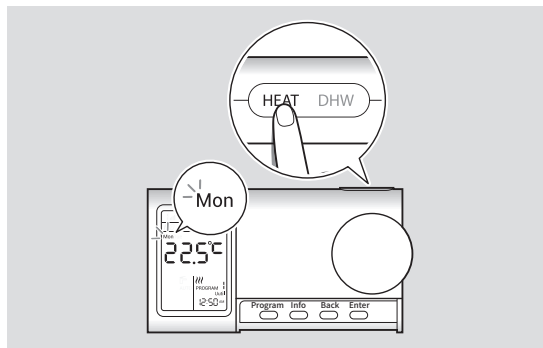

- The default screen of Program mode is central heating.
- The default day settings for Program mode is 7 days. To change the program day settings, refer to “Setting the program day” on page 38.

- 3 Rotate the encoder up or down to select the weekday, and then press the Enter button to confirm it.

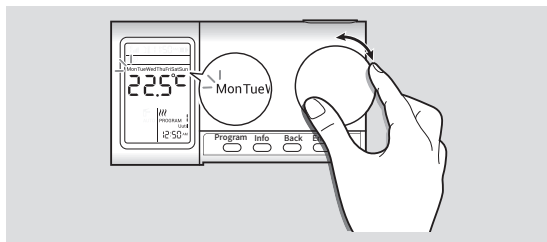

- 4 Rotate the encoder up or down to select the number of the programs to use (up to six programs), and then press the Enter button to confirm it.

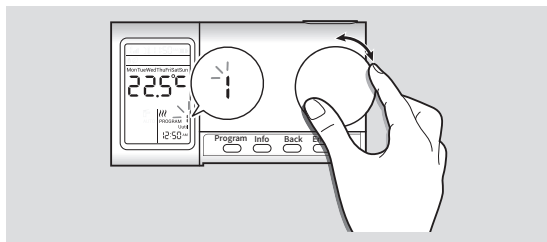

Program number	Mon to Fri	Sat and Sun	Set temperature
1	00:00	00:00	23°C
2	06:30	07:30	26°C
3	08:00	09:30	20°C
4	17:00	17:00	24°C
5	20:00	20:00	26°C
6	22:00	23:00	24°C

The following graph shows the each program's set temperature and time.

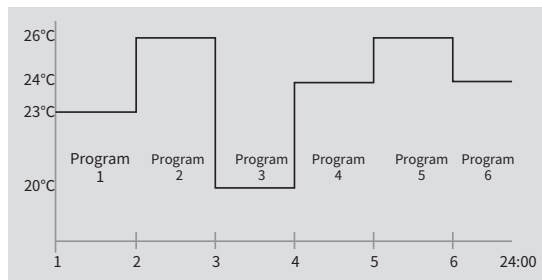

- 5 Rotate the encoder up or down to select the central heating temperature for each selected program, and then press the Enter button to confirm it.

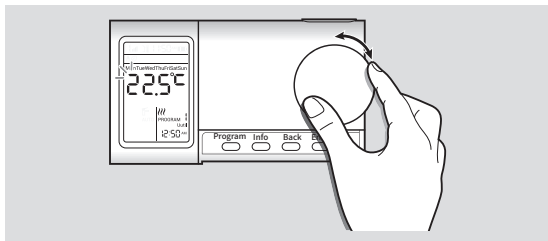

- 6 Rotate the encoder up or down to select the central heating starting hour, and then press the Enter button to confirm it.

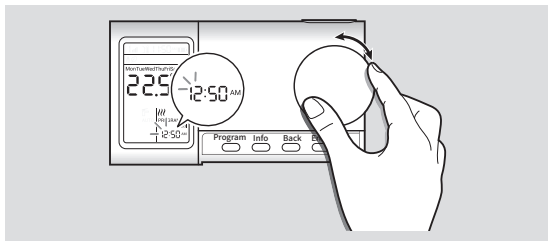

- 7 Rotate the encoder up or down to select the central heating starting minute, and then press the Enter button to confirm it.

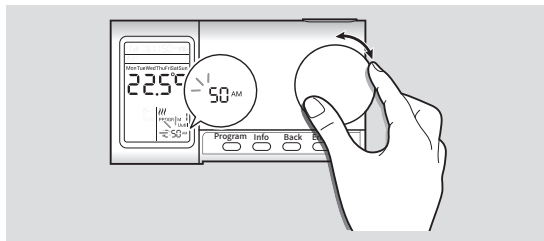

When you complete setting for every day through Sunday, the program mode settings will automatically end.



If you press the Back button while adjusting the program mode settings, the LCD screen will change to a normal operation status and save only the program number information it has saved through the central heating start minute sequence.



# Using the domestic hot water (DHW)

## Selecting the domestic hot water mode

You can select the various domestic hot water modes for a selected zone. To select a domestic hot water mode, press the DHW button sequentially to select the domestic hot water mode (AUTO, ON, ONCE, OFF, IntE (Intelligent)).



- Depending on the boiler type, DHW mode may not be enabled.
- To use DHW mode, the zone number must be set to [1].

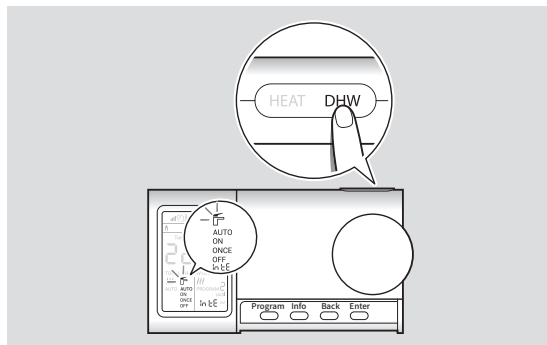

Each domestic hot water mode is explained in the following table.

Name	Description
AUTO	Domestic hot water is operated at the set time that was set in DHW program mode (Weekly Schedule).
ON	Domestic hot water is always operated.
ONCE	Domestic hot water starts operating from the first ON time to the last OFF time set in DHW program mode of the current week day (pre-heating).
OFF	Domestic hot water is not operated.
IntE (Intelligent)	<p>Pre-heating before domestic hot water operation is automatically performed based on cumulative user patterns.</p> <ul style="list-style-type: none"><li>• Approximately a week of cumulative DHW user patterns is required to use this mode properly.</li><li>• Depending on the boiler type, IntE (Intelligent) mode may not be usable.</li></ul>

## Setting the domestic hot water program (Schedule settings)

If you set a program (Schedule settings), you can select the desired day and time to operate the domestic hot water system. Setting a program for use of domestic hot water can only be performed by the Zone 1 thermostat.

- 1 Press the Program button to enter Program mode. “ProG” will blink on the LCD screen.

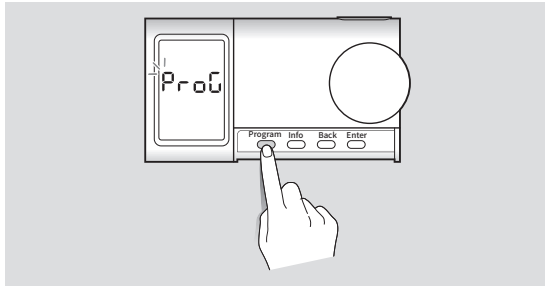

- 2 Press the DHW button to enter DHW Program mode. The days of the week will blink on the LCD screen.

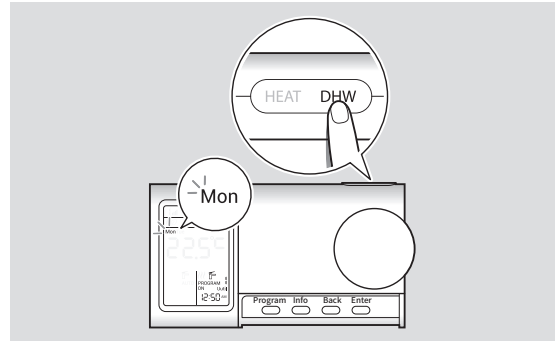

-  The default program settings for Program mode is 7 days. To change the program day settings, refer to “Setting the program day” on page 38.

- 3 Rotate the encoder up or down to select the weekday, and then press the Enter button to confirm it.

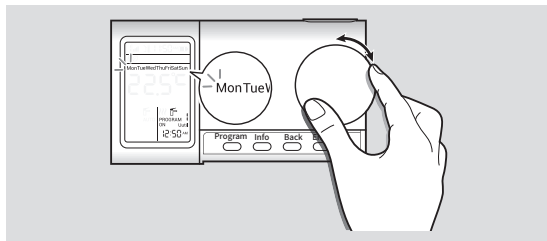

- 4 Rotate the encoder up or down to select the number of the programs to use (up to six programs), and then press the Enter button to confirm it.

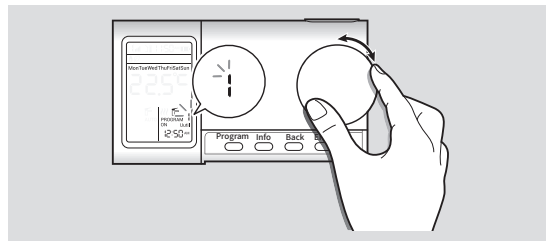

Program number	Mon to Fri	Sat and Sun	Operation status
1	00:00	00:00	OFF
2	06:30	07:30	ON
3	08:00	09:30	OFF
4	17:00	17:00	ON
5	20:00	20:00	OFF
6	22:00	23:00	OFF

- 5 Rotate the encoder up or down to select **ON** or **OFF** to use the domestic hot water for each of selected programs, and then press the Enter button to confirm it.

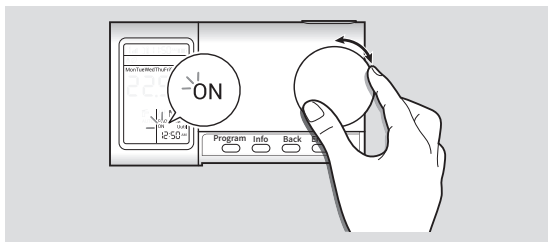

- 6 Rotate the encoder up or down to select the domestic hot water starting hour, and then press the Enter button to confirm it.

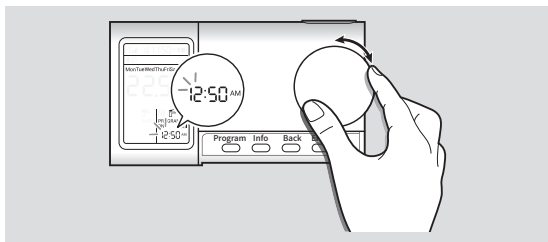

- 7 Rotate the encoder up or down to select the domestic hot water starting minute, and then press the Enter button to confirm it.

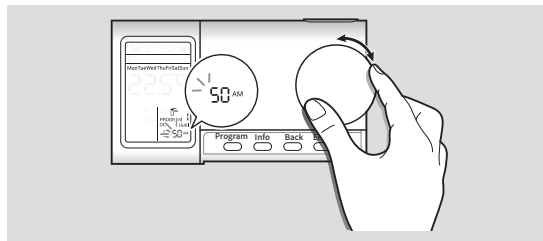

When you complete setting every day through Sunday, the program mode settings will automatically end.



If you press the Back button while adjusting the program mode settings, the LCD screen will change to a normal operation status and save only the program number information it has saved through the domestic hot water start minute sequence.

## Viewing basic information

You can view information about the use of the central heating and domestic hot water on the LCD screen.

Press the Info button, and then rotate the encoder up or down to change the information items.

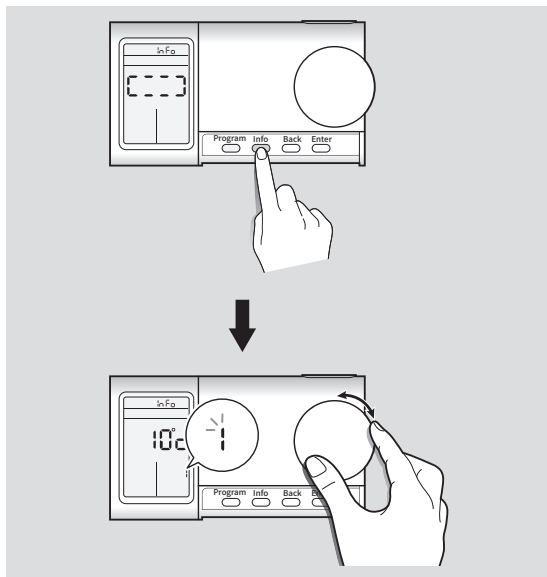

Each information item is explained in the following table.

No.	Item	Description
1	Outdoor temperature	Displays the current outdoor temperature. If the wireless communication module connected to the Wi-Fi network cannot receive the outdoor temperature data from the server, the outdoor temperature will not be displayed on the LCD screen.
2	Central heating operation time	Displays the total central heating usage time.
3	Central heating fuel usage	Displays the total fuel (oil or gas) usage for central heating operation.
4	Domestic hot water operation time	Displays the total domestic hot water operation usage time.
5	Domestic hot water fuel usage	Displays the total fuel (oil or gas) usage for domestic hot water operation.

No.	Item	Description
6	Total operation time	Displays the total operation time of both central heating and domestic hot water.
7	Total fuel usage	Displays the total fuel usage of both central heating and domestic hot water operation.
8	Maintenance requirement date	Displays the boiler's maintenance requirement date.



- The total operation time and total fuel usage displayed on the LCD screen are calculated for the boiler only. Actual total operation time and total fuel usage may vary.
- If no buttons including the encoder are used for more than 20 seconds, or if you press the Back button while in information mode, the LCD screen will return to normal operation status.

## Using advanced functions

The wireless thermostat provides advanced functions with various modes, such as child-lock mode, holiday mode, pre-heat function, and freeze protection for safety and unit protection.

### Using child-lock mode

To prevent children from adjusting the temperatures of central heating and domestic hot water via the encoder, you can activate child-lock mode. When child-lock mode is activated, you cannot use the encoder, but other buttons can be used.

To activate child-lock mode, press and hold the Program and Info buttons simultaneously.

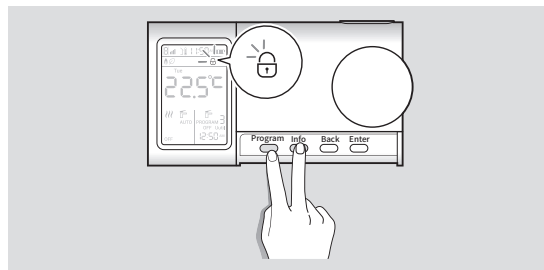

If child-lock mode is activated, the child-lock icon (🔒) will be displayed on the LCD screen and the encoder will be locked.

To deactivate child-lock mode, press and hold the Program and Info buttons simultaneously until the child-lock icon (🔒) disappears on the LCD screen.

## Using holiday mode

If you are away from home for a long holiday and do not need to use the boiler for an extended period, activate holiday mode to save fuel and protect the boiler. If holiday mode is activated, the central heating system is not operated.

- 1 Press and hold the Back and Enter buttons simultaneously to open the User setting menu.

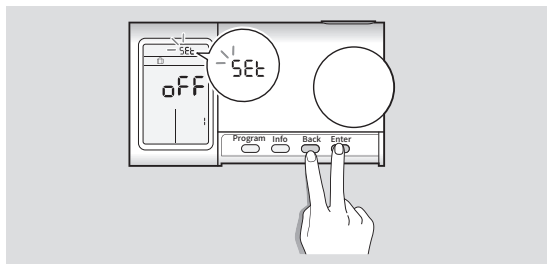

If you do not press any buttons or rotate the encoder for more than 10 seconds in the User setting menu, the LCD screen will change to a normal operation status.

- 2 Rotate the encoder up or down to select **1** (Holiday mode), and then press the Enter button.

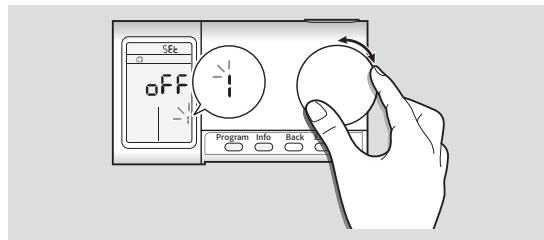

- 3 Rotate the encoder up or down to select **OFF** (default) or **ON**, and then press the Enter button to activate or deactivate holiday mode.

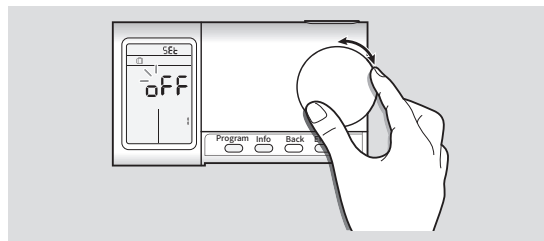

If holiday mode is activated, the holiday mode icon (🏠) will be displayed on the LCD screen.

## Using the pre-heat function

If you activate the pre-heat function, pre-heating will be activated to provide the optimum temperature ten minutes before the set program time during AUTO mode.

- 1 Press and hold the Back and Enter buttons simultaneously to open the User setting menu.

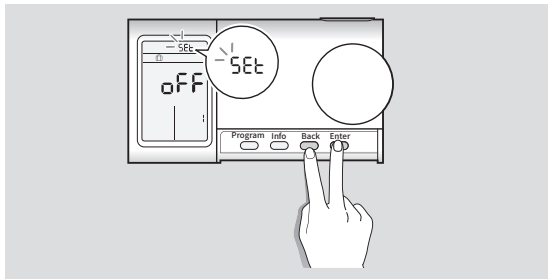

- 2 Rotate the encoder up or down to select **2** (Pre-heat function), and then press the Enter button.

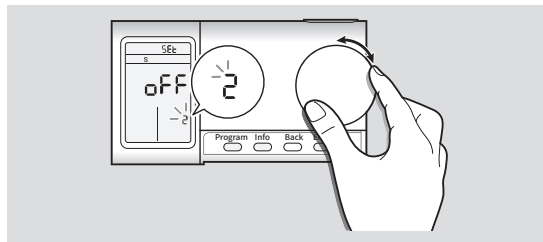

- 3 Rotate the encoder up or down to select **OFF** (default) or **ON**, and then press the Enter button to activate or deactivate the pre-heat function.

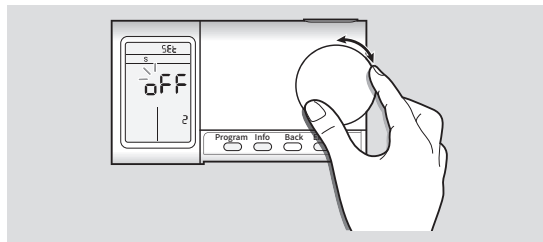

If the pre-heat function is activated, the pre-heat function icon ( **S** ) will be displayed on the LCD screen.



## Using the freeze protection function

If you activate the freeze protection function, you can protect the boiler from freezing.



If freeze protection is set in boiler, then it is not activated by thermostat.

- 1 Press and hold the Back and Enter buttons simultaneously to open the User setting menu.

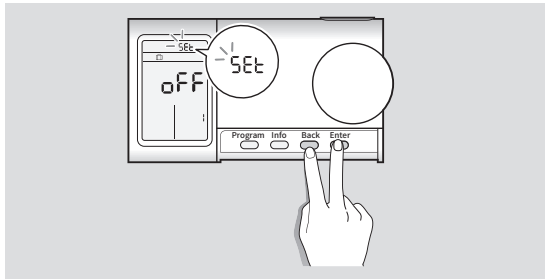

- 2 Rotate the encoder up or down to select **3** (Freeze protection function), and then press the Enter button.

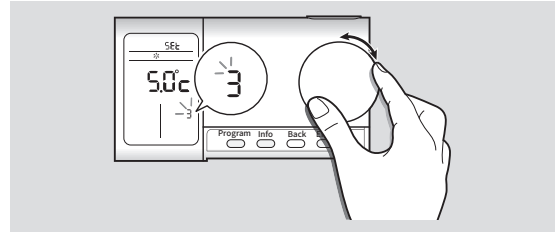

- 3 Rotate the encoder up or down to select the desired temperature from **0°C to 10°C** (default: 5°C), and then press the Enter button to confirm the setting.

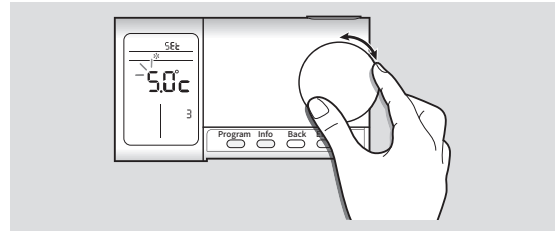

If the freeze protection function is activated, the freeze protection function icon (❄️) will be displayed on the LCD screen.

# Setting the user configurations

## Selecting 12H 24H format

You can select the desired time format to display on the LCD screen.

- 1 Press and hold the Back and Enter buttons simultaneously to open the User setting menu.

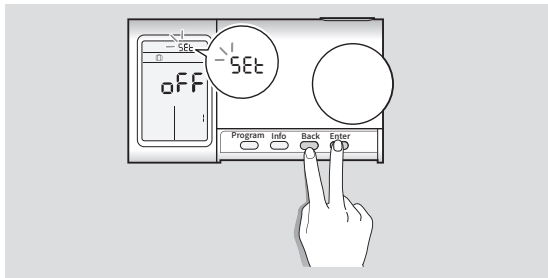

- 2 Rotate the encoder up or down to select **4** (Time format settings), and then press the Enter button.

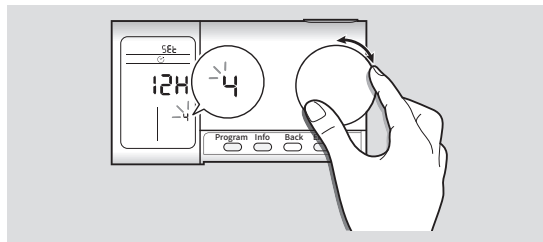

- 3 Rotate the encoder up or down to select **12H** (default) or **24H**, and then press the Enter button to confirm it.

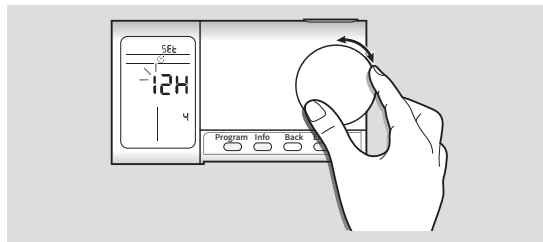

# Setting the installer configurations

## Changing the zone number

In the Installer setting menu, you can change the zone number after having selected and confirmed it.

- 1 Press and hold the Info and Enter buttons simultaneously to open the Installer setting menu.

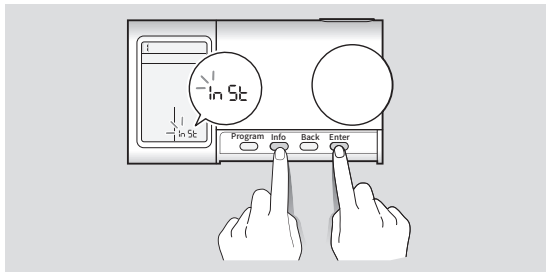

If you do not press any buttons or rotate the encoder for more than 10 seconds in the Installer setting menu, the LCD screen will change to a normal operation status.

- 2 Rotate the encoder up or down to select 1 (Zone number settings), and then press the Enter button to confirm it.

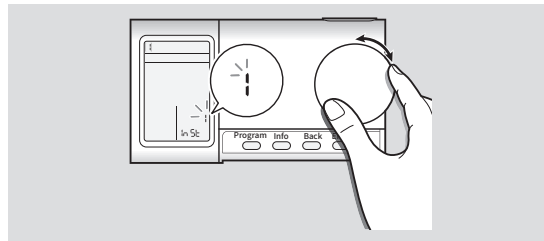

- 3 Rotate the encoder up or down to select a desired zone number from [1] to [3], and then press the Enter button to confirm it.

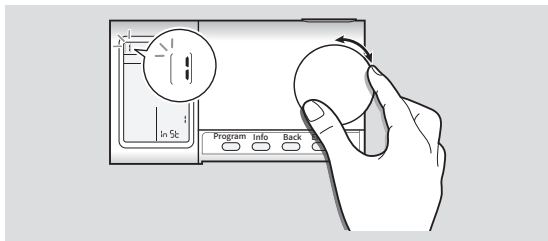

After changing the zone number, you should pair the wireless thermostat with the wireless communication module again. To pair with the wireless communication module, refer to “Pairing with the wireless communication module” on page 18.

## Calibrating the indoor temperature

In the Installer setting menu, you can calibrate the indoor temperature.

- 1 Press and hold the Info and Enter buttons simultaneously to open the Installer setting menu.

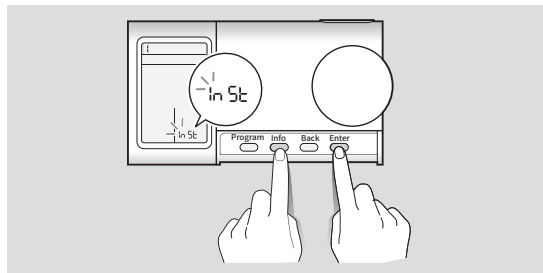

- 2 Rotate the encoder up or down to select 2 (Temperature calibration), and then press the Enter button to confirm it.

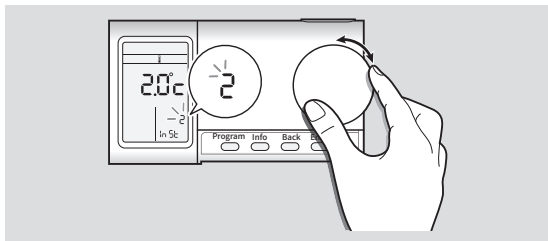

- 3 Rotate the encoder up or down to select a desired calibrated indoor temperature value from -5°C to +5°C, and then press the Enter button to confirm it.

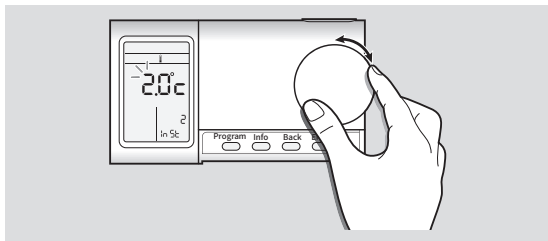

## Testing the RF signal

After pairing the wireless thermostat with the communication module, you can test the RF signal between the wireless thermostat and the communication module.

- 1 Press and hold the Info and Enter buttons simultaneously to open the Installer setting menu.

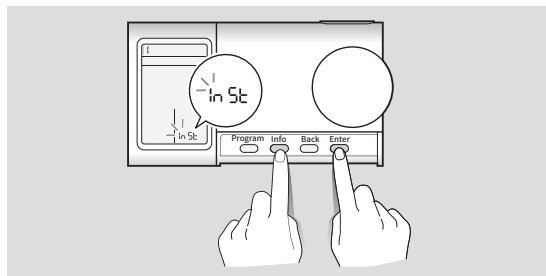

- 2 Rotate the encoder up or down to select **3** (RF signal test), and then press the Enter button.

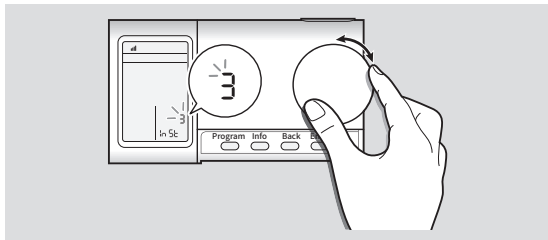

The RF test will proceed and the RSSI values will be converted and displayed along with the antenna signal and numbers.



- To view the updated RSSO values, press the Enter button again.
- If the wireless thermostat is not paired with the communication module successfully, the RSSI values will be displayed as [0].

## Setting the program day

The default day settings for Program mode is 7 days. In the Installer setting menu, you can change the program day settings 5+2 days (weekday, weekend) or 5+1+1 days (weekday, Saturday, Sunday).

- 1 Press and hold the Info and Enter buttons simultaneously to open the Installer setting menu.

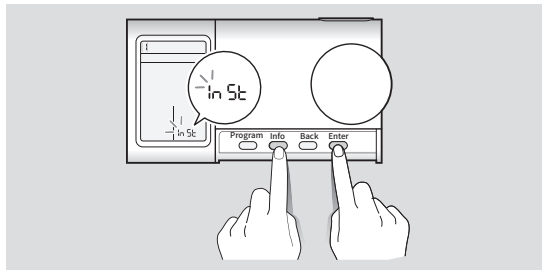

- 
- 2 Rotate the encoder up or down to select **4** (Program setting mode), and then press the Enter button to confirm it.

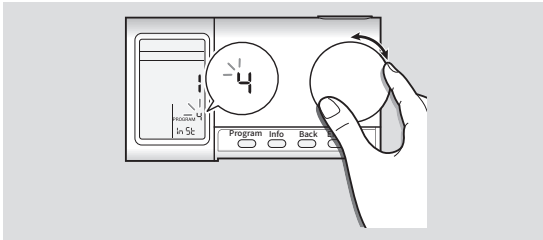

- 3 Rotate the encoder up or down to select **1** (7 days), **2** (5+2 days), **3** (5+1+1 days), and then press the Enter button to confirm it.

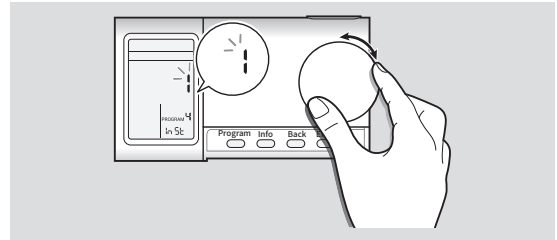

Each setting value is explained as follows.

- **1** (7 Days): The programs for each day from Monday to Sunday can be set.
- **2** (5+2 Days): The programs for weekday and weekend from Monday to Friday and Saturday to Sunday can be set.
- **3** (5+1+1 Days): The programs for weekday and weekend from Monday to Friday, Saturday or Sunday can be set.

## Setting the date and time

In the Installer setting menu, you can set the date and time manually.



- The date and time on the LCD screen is automatically updated via the Wi-Fi network, if the communication module is connected to the Wi-Fi network.
- The date and time can only be set via the Zone 1 thermostat.
- The default date and time is Mon 1 Jan 2019 12:00 am.

- 1 Press and hold the Info and Enter buttons simultaneously to open the Installer setting menu.

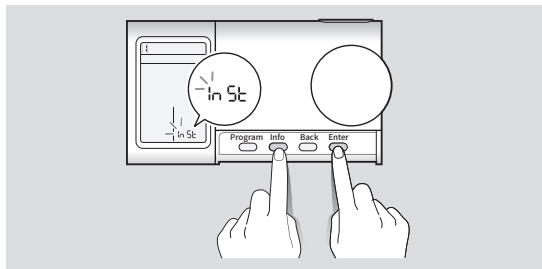

- 2 Rotate the encoder up or down to select 5 (Date and time settings), and then press the Enter button to confirm it.

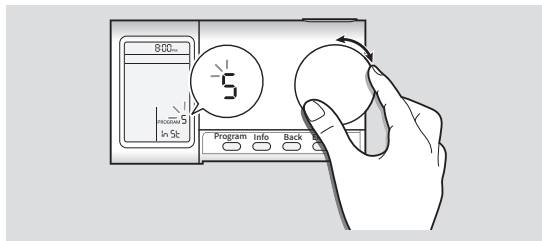



- 
- 3 Rotate the encoder up or down to select the desired year, and then press the Enter button to confirm it.
  - 4 Rotate the encoder up or down to select the desired month, and then press the Enter button to confirm it.
  - 5 Rotate the encoder up or down to select the desired date, and then press the Enter button to confirm it.
  - 6 Rotate the encoder up or down to select the desired day, and then press the Enter button to confirm it.
  - 7 Rotate the encoder up or down to select the desired hour, and then press the Enter button to confirm it.
  - 8 Rotate the encoder up or down to select the desired minute, and then press the Enter button to confirm it.

## Resetting the accumulated fuel usage and operation time

In the Installer setting menu, you can reset the accumulated fuel usage and operation time.

- 1 Press and hold the Info and Enter buttons simultaneously to open the Installer setting menu.

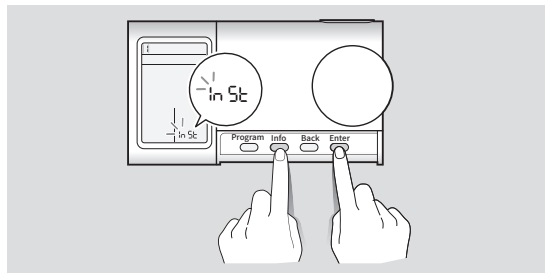

- 2 Rotate the encoder up or down to select **6** (Accumulated fuel usage and operation time reset), and then press the Enter button to confirm it.

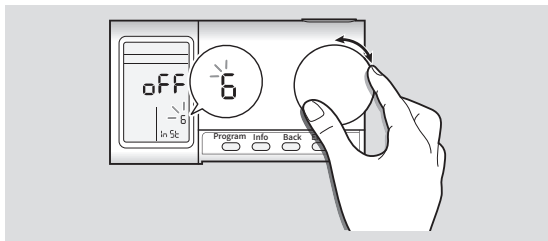

- 3 Rotate the encoder up or down to select **OFF** or **ON**, and then press the Enter button to confirm it.

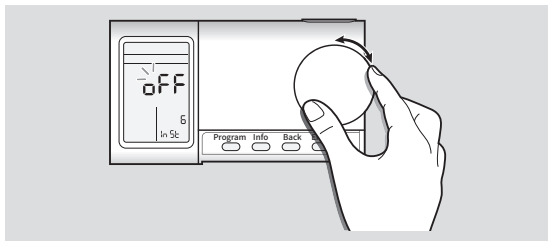

## Resetting the wireless thermostat

In the Installer setting menu, you can reset the all the data, including set program data.



Pairing information is not reset.

- 1 Press and hold the Info and Enter buttons simultaneously to open the Installer setting menu.

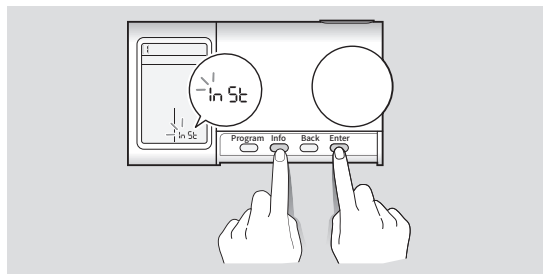

- 
- 2 Rotate the encoder up or down to select **7** (Factory reset), and then press the Enter button to confirm it.

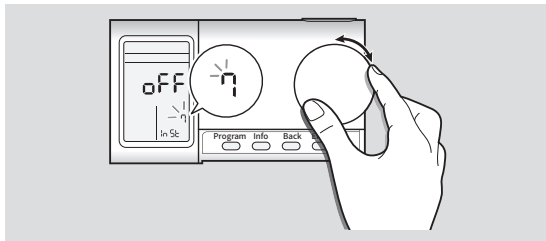

- 3 Rotate the encoder up or down to select **OFF** or **ON**, and then press the Enter button to confirm it.

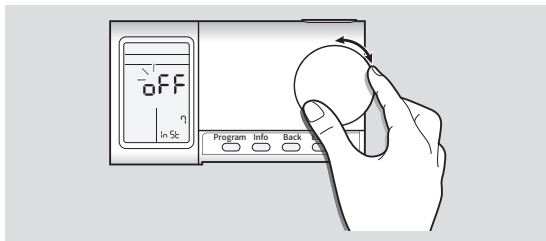

# Troubleshooting

---

Before reporting a malfunctioning device, refer to the following table and see if you can identify and fix the problem.

Fault situation	Suggested remedies
The wireless thermostat cannot be paired with the communication module.	<ul style="list-style-type: none"><li>• Check if the communication module is in pairing mode when attempting to pair with the communication module.</li><li>• Check if you have changed the zone number. After changing the zone number, you should pair the wireless thermostat with the wireless communication module again.</li></ul>
The RF signal strength icon (  ) on the LCD screen does not appear or its strength is low.	<ul style="list-style-type: none"><li>• Check if the wireless thermostat is installed in an open area near the wireless communication module.</li><li>• If the RF connection experiences interference from nearby electrical equipment or buildings, choose a different installation location.</li><li>• Check the remaining battery amount. If the remaining battery amount is low, the wireless thermostat may not communicate with the wireless communication module properly. Replace the old batteries with new ones and pair the wireless thermostat with the wireless communication module again.</li></ul>
The central heating or domestic hot water system does not operate properly.	<ul style="list-style-type: none"><li>• Check if the desired central heating or domestic hot water mode is set properly.</li><li>• Check the boiler's settings if a DHW tank and other units connected to the boiler are used.</li><li>• Check the wiring centre's settings if an aquastat or a tank sensor is used.</li></ul>
Either central heating or the domestic hot water system does not operate.	Check if an error from the boiler has occurred. If a boiler error has occurred, check the error status and resolve the error.

## Error Code Guide

---

When an error code appears on the LCD screen, refer to the following table for a definition and possible remedy for the situation.

Error code	Reason	Self-diagnostic / Action
E001	Displays when a boiler lock out has occurred.	Resolve the boiler's error.
E002	Displays when the wireless communication module and wiring centre are not communicating each other.	Check if the wireless communication module and wiring centre are properly paired.
E004	Displays when a temperature sensor error from the wiring centre paired with the wireless communication module has occurred.	Check the temperature sensor connected with the wiring centre.
E008	Displays when the wireless communication module and the boiler are not communicating each other.	Check if the KIW communication cable from the boiler is connected to the wireless communication module properly.

# Recycling and disposal

---

## Recycling the package

Sort out the waste to separate that which can be recycled (cartons, plastics, etc.) from the various wastes that cannot be recycled (straps, etc.). Also recycle the product's packaging in accordance with all relevant local regulations.

## WEEE: Recycling or disposing of the device and its parts



- The device must be recycled in compliance with the WEEE Directive (Waste Electrical and Electronic Equipment), which specifies the:
  - selective collection of waste electrical and electronic equipment.
  - selective systematic treatment of certain components and substances considered to be dangerous,
  - reuse, recycling, and recovery of the collected waste electrical and electronic equipment.
- Do not dispose of the device or any of its accessories with your regular household waste.
- Ensure that the old unit and any of its accessories are appropriately disposed of.
- Deposit the product at an appropriate collection point for evaluating, treating, and recycling waste electrical and electronic equipment.
- Observe all relevant regulations and laws.

## Warranty

---

Manufacturer's warranty of 2 years is provided. This warranty does not cover damage caused by mishandling such as accidental drops or collisions.

# Specifications

---

The following table lists the specifications for the wiring centre.

Items		Specifications
Power supply	Main supply	2 x AA batteries
	Power consumption	50 mW
Radio frequency (RF)		865.15 MHz–867.95 MHz
Permissible operating temperature		0 °C–40 °C



- There is a risk of explosion if the battery is replaced using an incorrect type.
- Dispose of used batteries according to the instructions.

Supplier's name: KDEL (KYUNG DONG ELECTRONICS CO., Ltd.)

Supplier's model identifier: NRC-10R (Wireless thermostat)

ErP control class	Space heating energy efficiency	Description
VI	+4%	Weather compensator and room sensor, for use with modulating heaters
VIII	+5%	Multi-sensor room temperature control, for use with modulating heaters





- Must be supplied from a power source of less than 8 A, 100 VA
- We suggest using only the accessories provided with the product. Using third-party accessories may result in signal interference or improper operation of the product or other nearby devices.
- The product's wireless power supply follows all related RF standards. If the product's voltage and temperature become too low or high or the product is subject to any abnormal operation, the product's power supply may become unstable and impact performance.
- We suggest using only the accessories provided with the product. The product's wireless power supply follows all related RF standards. Using third-party accessories, allowing the product's voltage and temperature to become too low or high, or subjecting the product to any abnormal operation may cause the product's wireless power supply to become unstable and impact performance.
- The product's short range wireless communication function is controlled via software or firmware to meet standards related to data transfer security. If the software or firmware is improperly modified or changed, the product's data transfer security may not function properly.
- This product's wireless communication antenna does not require SAR testing, because the operating distance is more than 20 cm and conforms to EN62311.
- This product's safety/RF/EMC have already been tested by a qualified laboratory and received passing marks, but any abnormal operation method or conditions may make the product stop working or experience a malfunction.

Certification 

Manufactured by KDEL(KYUNG DONG ELECTRONICS CO., Ltd.) [www.kdelectronics.co.kr](http://www.kdelectronics.co.kr)  
7F, KOAMI Bldg., 22, Gukhoe-daero 76-gil, Yeongdeungpo-gu, Seoul, (07238) KOREA  
Tel : +82-31-8060-5500

**Memo**

---

**Memo**

---

<https://navienuk.com/>



T H E L E A D E R I N C O N D E N S I N G T E C H N O L O G Y