

USER'S INFORMATION MANUAL

CAST IRON - GAS FIRED RESIDENTIAL STEAM BOILERS

WARNING: If the information in this manual is not followed exactly, a fire or explosion may result causing property damage, personal injury or loss of life.

- Do not store or use gasoline or other flammable vapors and liquids in the vicinity of this or any other appliance.

- WHAT TO DO IF YOU SMELL GAS
 - Do not try to light any appliance.
 - Do not touch any electrical switch; do not use any phone in your building.
 - Immediately call your gas supplier from a neighbor's phone. Follow the gas supplier's instructions.
 - If you cannot reach your gas supplier, call the fire department.

- Installation and service must be performed by a qualified installer, service agency or the gas supplier.

Do not use this boiler if any part has been under water. Immediately call a qualified service technician to inspect the boiler and to replace any part of the control system and any gas control which has been under water.

Should overheating occur or the gas supply fail to shut off, do not turn off or disconnect the electrical supply to the pump. Instead, shut off the gas supply at a location external to the appliance.



Manufactured by:
ECR International Inc.
2201 Dwyer Avenue, Utica, NY 13501
Tel. 800 325 5479
www.ecrinternational.com
PN 240013741 REV. A [12/01/2022]

Become familiar with symbols identifying potential hazards.



This is the safety alert symbol. Symbol alerts you to potential personal injury hazards. Obey all safety messages following this symbol to avoid possible injury or death.

⚠ DANGER
Indicates a hazardous situation which, if not avoided, WILL result in death or serious injury

⚠ WARNING
Indicates a hazardous situation which, if not avoided, could result in death or serious injury.

⚠ CAUTION
Indicates a hazardous situation which, if not avoided, could result in minor or moderate injury.

NOTICE
Used to address practices not related to personal injury.

1- General

This boiler has few user serviceable parts. Maintenance and Service must be completed by qualified agency.

⚠ WARNING
Fire, explosion, asphyxiation and electrical shock hazard. Improper maintenance and service could result in death or serious injury. Read this manual and understand all requirements, including use of qualified agency where directed.

**KEEP THIS MANUAL NEAR BOILER
RETAIN FOR FUTURE REFERENCE**

Maintenance and Service must be completed by qualified agency.

FOR YOUR SAFETY READ BEFORE OPERATING

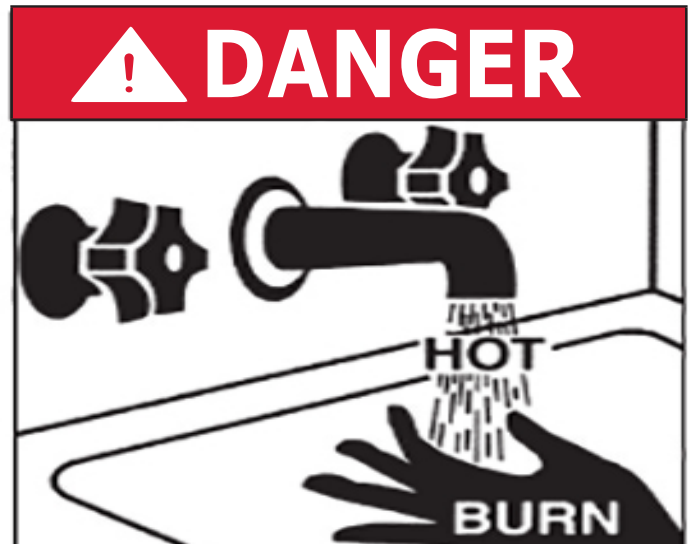

Hot Water Can Scald!

Water heated to temperature for clothes washing, dish washing and other sanitizing needs can scald and cause permanent injury.

Children, elderly, and infirm or physically handicapped persons are more likely to be permanently injured by hot water. Never leave them unattended in bathtub or shower. Never allow small children to use a hot water tap or draw their own bath.

If anyone using hot water in the building fits the above description, or if state laws or local codes require certain water temperatures at hot water taps, you must take special precautions:

- Use lowest possible temperature setting.
- Install some type of tempering device, such as an automatic mixing valve, at hot water tap or water heater. Automatic mixing valve must be selected and installed according to manufacturer's recommendations and instructions.
- Water passing out of drain valves may be extremely hot. To avoid injury:
- Make sure all connections are tight.
- Direct water flow away from any person.

Water Temperature Setting	1st Degree Burn Exposure Time For An Adult	2nd and 3rd Degree Burn Exposure Time For An Adult
120° F	1 minute	5 minutes
130° F	5 seconds	30 seconds
140° F	2 seconds	5 seconds
150° F	1 second	1.5 seconds
160° F	Instantaneous	0.5 seconds

Note: Warning for Infants, Children, and Elderly: Great care must be taken when exposing the aforementioned groups to warm or hot water as they can be badly burned in exposure times less than half of the time for an adult.

⚠ WARNING

Fire, explosion, and asphyxiation hazard. Before lighting verify boiler contains water visible in gauge glass. Failure to follow these instructions could result in death or serious injury.

⚠ WARNING

Combustion chamber insulation in this product contains ceramic fiber material. Ceramic fibers can be converted to cristobalite in very high temperature applications. The International Agency for Research on Cancer (IARC) has concluded, Crystalline silica inhaled in the form of quartz or cristobalite from occupational sources is carcinogenic to humans (Group1). Avoid breathing dust and contact with skin and eyes. Use NIOSH certified dust respirator (N95). This type of respirator is based on the OSHA requirements for cristobalite at the time this document was written. Other types of respirators may be needed depending on the job site conditions. Current NIOSH recommendations can be found on the NIOSH website <https://www.cdc.gov/niosh/topics/silica/>. NIOSH approved respirators, manufacturers, and phone numbers are also listed on this website. Wear long-sleeved, loose fitting clothing, gloves, and eye protection. Apply enough water to the combustion chamber lining to prevent dust. Wash potentially contaminated clothes separately from other clothing. Rinse clothes washer thoroughly.

NIOSH stated First Aid. Eye: Irrigate immediately. Breathing: Fresh air.

⚠ WARNING

Fire, Explosion, Asphyxiation, Electrical shock hazard! Flooding will result in damages such as electrical problems, corrosion, inoperative parts, mold and other unforeseen issues which can occur over time. Any equipment determined by a professional as damaged by a flood, defined as excess of water or other liquid, shall be replaced. Failure to follow these directions will result in a Hazardous Situation.

⚠ WARNING

This product contains Fibrous glass. Fibrous glass is a synthetic fiber made from tiny particles of glass. Fibrous glass has been classified as a possible human carcinogen. When disturbed as a result of servicing or repair, fibrous glass becomes airborne and, if inhaled, may be hazardous to your health. It can harm the eyes, skin, and the lungs. Airborne fibers from these materials have been listed by the State of California as a possible cause of cancer through inhalation. Adhere to the following precautions and procedures. Avoid breathing dust and contact with skin and eyes. Use NIOSH certified dust respirator (e.g., N95). Other types of respirators may be needed depending on the job site conditions. Current NIOSH recommendations can be found on the NIOSH website <https://www.cdc.gov/niosh/>. Approved respirators, manufacturers, and phone numbers are also listed on this website. Wear appropriate personal protective clothing to prevent skin contact, as well as gloves and eye protection. Wash skin daily at end of each work shift, and prior to eating, drinking, smoking, etc. Workers whose clothing may have been contaminated should change into uncontaminated clothing before leaving the work premises. Wash potentially contaminated clothes separately from other clothing. Rinse clothes washer thoroughly. Follow all Local, State and Federal guidelines for disposal.

NIOSH stated First Aid. Eye: Irrigate immediately. Breathing: Fresh air.

⚠ CAUTION

Laceration, burn hazard. Metal edges and parts may have sharp edges and/or may be hot. Use appropriate personal protection equipment to include safety glasses and gloves when installing or servicing this boiler. Failure to follow these instructions could result in minor or moderate injury.

⚠ WARNING

If you do not follow these instructions exactly, a fire or explosion may result causing property damage, personal injury or loss of life.

- This appliance is equipped with an ignition device which automatically lights burner. Do NOT try to light this burner by hand.
- Before operating smell all around appliance area for gas. Be sure to smell next to floor because some gas is heavier than air and will settle to the floor.
- Use only your hand to turn the gas shutoff valve. Never use tools. If valve will not turn by hand, do not try to repair it, call a qualified service technician. Force or attempted repair may result in fire or explosion.
- Do not use this appliance if any part has been under water. Immediately call a qualified service technician to inspect appliance and to replace any part of control system and any gas control which has been under water.
- Do not operate boiler if hot water boiler and system are not full of water to minimum pressure of 12 psi. Verify system is vented of air.

1. What To Do Should Overheating Occur

Do not turn off or disconnect electrical supply to pumps. Shut off gas supply at location external to appliance.

2. What To Do If Boiler Or Any Part Has Been Under Water

Do not use boiler if any part has been under water. Immediately call a qualified service technician to inspect boiler and to replace any part of control system and any gas control which has been under water.

3. This product burns gas to produce heat. The appliance must be properly installed, operated, and maintained to avoid exposure to appreciable levels of carbon monoxide and the installer is required to confirm that at least one carbon monoxide alarm is installed in the living space before the appliance is put into operation. It is important for the carbon monoxide alarms to be installed, maintained, and replaced following the alarm manufacturer's instructions and applicable local codes.

⚠ CAUTION**WHAT TO DO IF YOU SMELL GAS**

- Do not try to light any appliance.
- Do not touch any electrical switch; do not use any phone in your building.
- Immediately call your gas supplier from a neighbor's phone. Follow the gas supplier's instructions.
- If you cannot reach your gas supplier, call the fire department.

2.1 Operating Instructions

Stop! Read Safety information above.





- Set thermostat to lowest setting.
- Turn "**OFF**" all electrical power to appliance.
- This appliance is equipped with an ignition device which automatically lights the burner. **Do not try to light burner by hand!**
- Lift and remove front door.
- Turn gas control knob clockwise  to closed position. See Figure 2-1
- Wait 5 minutes for any gas to clear. Smell for gas, including near floor. If you smell gas, **STOP!** Follow instructions on this page: "**What To Do If You Smell Gas.**" If you do **not** smell gas, go to next step.
- Turn gas control knob counter clockwise  to open position.
- Turn "**ON**" electrical power to appliance.
- Set thermostat to desired setting.
- If the appliance will not operate, follow instructions TO TURN OFF GAS TO APPLIANCE and call your service technician or gas supplier.

Figure 1- 1 - Gas Valve

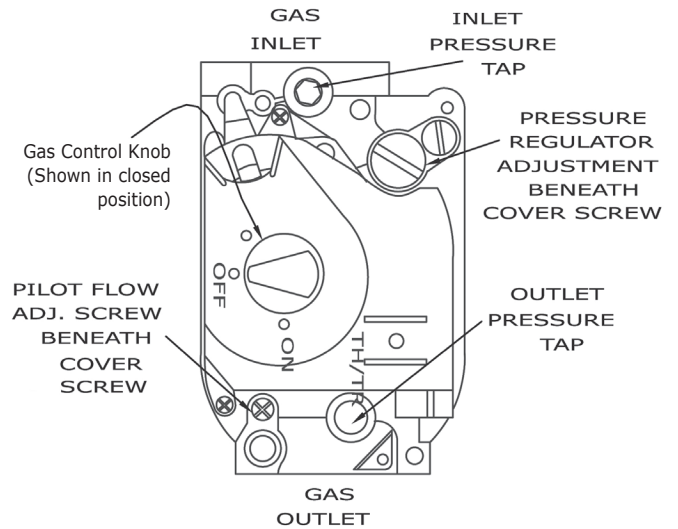

2.2 To Turn Off Gas To Appliance

- Set thermostat to lowest setting.
- Turn "**OFF**" all electric power to appliance if service is to be performed.
- Remove access panel(s).
- Turn gas shutoff control knob clockwise  to closed position.
- Replace access panel(s).

WARNING

Fire and Asphyxiation hazard. Do not attempt to place boiler in operation if safety switches shut the main burner gas off. Contact a qualified service agency. Failure to follow these instructions could result in death or serious injury.

WARNING

Burn and scald hazard. Discharge of water, vapor and steam may scald. Water and steam are under pressure, open all valves slowly. Failure to follow these instructions could result in death or serious injury.

WARNING

Burn and scald hazard. Verify Safety Relief Valve discharge piping run to safe discharge location before conducting maintenance procedure. Contact qualified agency to correct improper piping.

3.1 Safety Features

- In event the flow of combustion products through boiler venting system becomes blocked, the blocked vent safety switch will shut main burner gas off. See Figure 2. **If this condition occurs, do not attempt to place boiler in operation. Contact a qualified service agency.**
- If boiler flue-ways become blocked, flame rollout safety switch will shut main burner gas off. See Figure 2. If this condition occurs, **do not attempt to place the boiler in operation. Contact a qualified service agency.**

3.2 Continuous

- Keep boiler area free from combustible materials, gasoline and other flammable vapors and liquids.
- Keep combustion air and vent terminations (outside building) free from trash, vegetation and other items capable of blocking flow.
- Insure water is present in the sight glass at all times. The water level may rise and fall as the boiler cycles on and off, this is normal. However, **water must always be visible in the sight glass (See figures 2 and 3).**

NOTICE

Boilers installed in residences commonly have an automatic, not manual, low water cutoff (unless required by codes). Confirm with the installer the type of low water cutoff your boiler is equipped with.

3.3 Beginning of Each Heating Season

- Contact qualified service agency to perform maintenance and cleaning per Installation, Operation and Maintenance manual.
- Inspection will include examining all flue product carrying areas, vent system, burner and pilot flames.
- Will also include filling boiler with water if drained as part of End of Heating Season procedure.

3.4 Weekly Maintenance

- Boilers are equipped with safety valve (steam). Refer to manufacture's instructions for operation and maintenance.
- If valve leaks steam when boiler is operating at normal pressure it must be replaced. Contact qualified service agent to replace or repair.

3.5 Monthly

- Inspect combustion air, vent piping for deterioration, leaks or sagging. Contact qualified agency, as necessary.
- Inspect system piping for leaks. Contact qualified agency, as necessary.
- Check air vent(s) for leakage.
- Follow OPERATING INSTRUCTIONS to return to normal operation.

3.6 Check According to Manufacturer's Instructions

Safety Relief Valve - Refer to manufacturer's instructions.

3.7 End of Heating Season, if boiler is not used for domestic hot water

- Follow instructions to TURN OFF GAS TO APPLIANCE. See section 2.2.
- Contact qualified agency to drain heating system (if system does not use antifreeze) if heating system is exposed to freezing temperatures while out of service.

GENERAL INSTRUCTIONS

⚠ WARNING

Burn and scald hazard. Discharge of water, vapor and steam may scald. Failure to follow these instructions could result in death or serious injury.

Figure 2 - Boiler Flue Gas Passageways

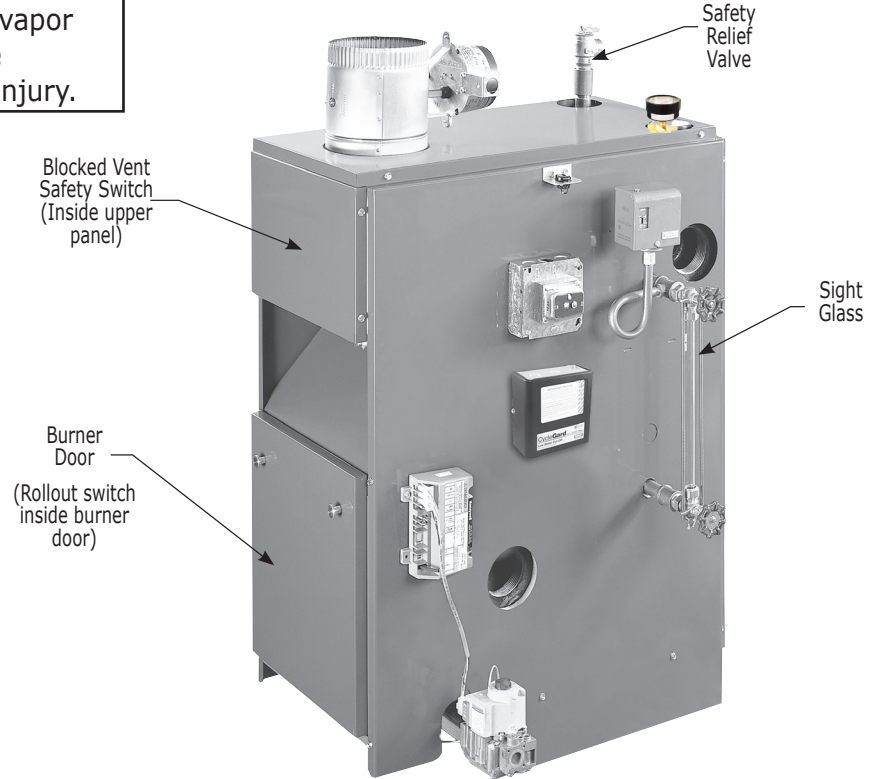
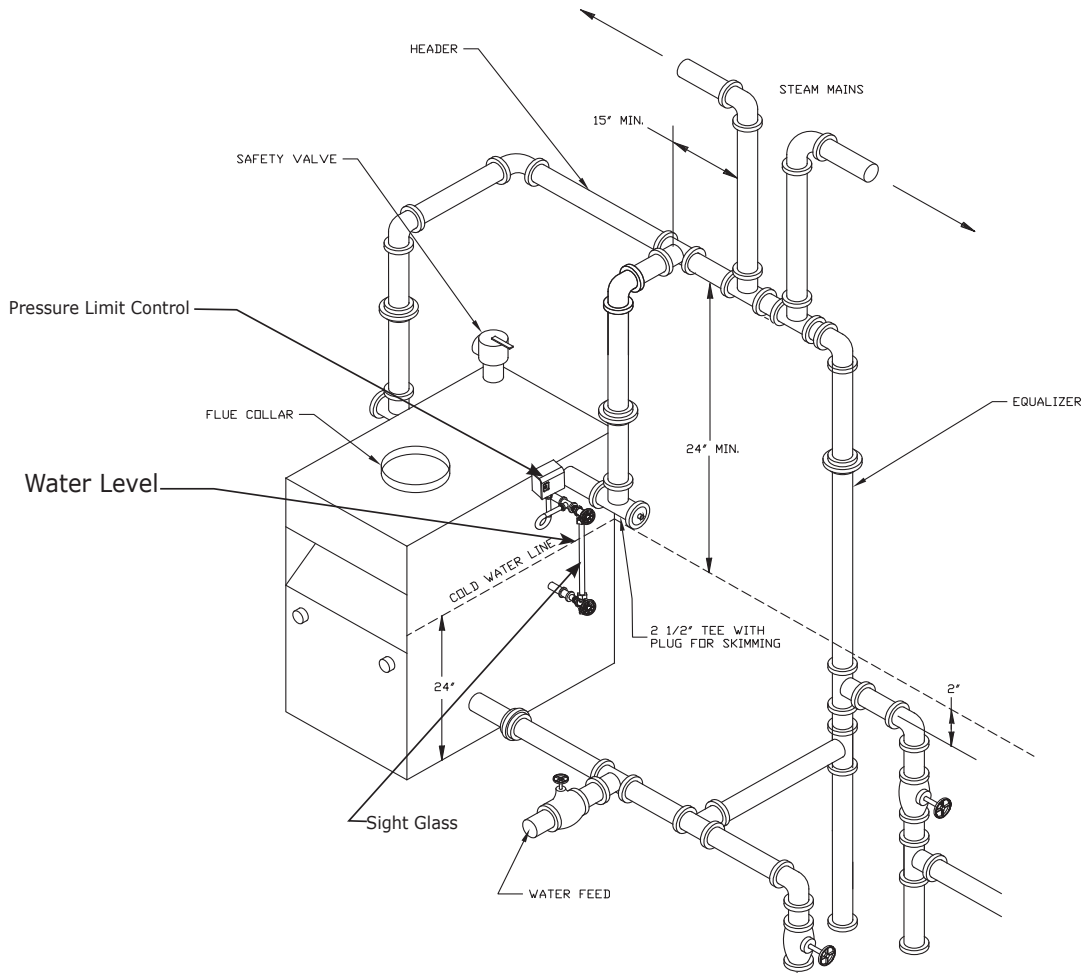

Figure 3 - Steam Boiler – Optimum Water Level With Boiler OFF and COLD



Installer Information

Name:	
Address:	
Phone:	Email:



ECRinternational

2201 Dwyer Avenue, Utica, NY 13501

Tel. 800 325 5479

www.ecrinternational.com

All specifications subject to change without notice.

©2022 ECR International, Inc.